

### 150 Watts

- Ultra Slim Design
- 150% Peak Load for 3 seconds
- Ambient Operation from -25 °C to +70 °C
- High Efficiency
- Selectable Overload Characteristic
- Selectable Remote Inhibit or Enable
- 3 Year Warranty



#### Dimensions:

**DSA150:**  
3.92 x 4.92 x 2.18" (99.8 x 125.2 x 55.5 mm)

### Models & Ratings

Output Voltage	Output Power	Output Voltage Trim <sup>(3)</sup>	Output Current	Peak Load <sup>(2)</sup>	Typical Efficiency <sup>(1)</sup>	Model Number
24 V	150 W	23.52-25.92 V	6.25 A	9.45 A	87%	DSA150PS24
48 V	150 W	47.04-51.84 V	3.125 A	4.8 A	87%	DSA150PS48

### Notes

1. Typical efficiency at 230 VAC and full load.
2. Peak load is for a maximum of 3 s, see Application Notes. Average power is not to exceed nominal output power.
3. Output current should be limited so that nominal output power is not exceeded.

### Mechanical Details

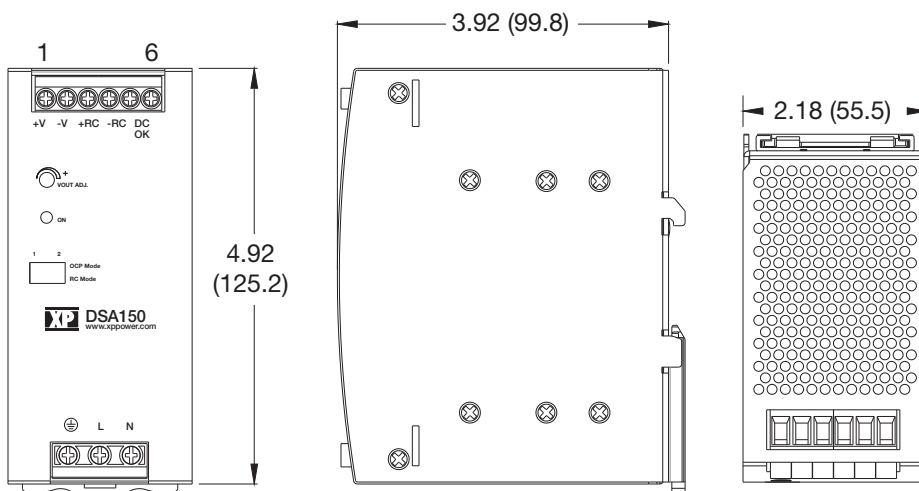

Pin Connector		
Conn	Pin	Designation
AC I/P	1	Ground
	2	L
	3	N
DC O/P	1	+Vout
	2	-Vout
	3	+RC
	4	-RC
	5	DC OK
	6	DC OK

### Input

Characteristic	Minimum	Typical	Maximum	Units	Notes & Conditions
Input Voltage - Operating	90		264	VAC	
Input Frequency	47	50/60	63	Hz	
Power Factor		0.9			At 230 VAC. Conforms to EN61000-3-2 Class A
Input Current - Full Load		1.6/0.8		A	115/230 VAC
Inrush Current			33/65	A	At 115/230 VAC
Earth Leakage Current			1.0	mA	At 264 VAC, 60 Hz
Input Protection	T5.0 A / 250 V internal in-line fuse				

### Output

Characteristic	Minimum	Typical	Maximum	Units	Notes & Conditions
Output Voltage - V1	24		48	VDC	See Models and Ratings table
Initial Set Accuracy			±1	%	At 100% load
Output Voltage Adjustment			-2/+8	%	See Models and Ratings table
Minimum Load	0			A	No minimum load required
Start Up Delay			1.0	s	
Start Up Rise Time			50	ms	
Hold Up Time	18			ms	At full load and 115 VAC
Line Regulation			±0.5	%	
Load Regulation			±1	%	
Transient Response - V1			4	%	Recovery within 1% in less than 2 ms for a 50% step load change at 0.2 A/μs
Ripple & Noise			1	% pk-pk	Measured at 20 MHz bandwidth
Overvoltage Protection	28		33	V	24 V model
	56		65	V	48 V model
Overload Protection				%	See Application Notes
Short Circuit Protection					Trip & restart (hiccup mode) for 5 cycles then latch. Recycle AC to reset.
Thermal Protection			95 (±5)	°C	Measured on internal heatsink auto recovery
Temperature Coefficient			0.03	%/°C	
Remote On/Off	Selectable as Enable or Inhibit using front panel switch				

### General

Characteristic	Minimum	Typical	Maximum	Units	Notes & Conditions
Efficiency		87		%	See Models & Ratings table
Isolation: Input to Output Input to Ground Output to Ground	3000			VAC	
	1500			VAC	
	500			VAC	
Switching Frequency		56/75		kHz	PFC/Main converter
DC OK Signal	Volt free contacts rated at 60 VDC/0.3 A, 30 VDC/1.0 A or 30 VAC/0.5 A (resistive load)				
Output LED	Green LED to indicate output on.				
Mean Time Between Failure		>250		kHrs	MIL-HDBK-217F, +25 °C GB
Weight		1.9 (860)		lb (g)	

### Environmental

Characteristic	Minimum	Typical	Maximum	Units	Notes & Conditions
Operating Temperature	-10		+70	°C	See derating curve in Application Notes
Storage Temperature	-40		+85	°C	
Cooling					Natural convection
Operating Humidity	20		95	%RH	Non-condensing
Operating Altitude			3000	m	
Shock					IEC68-2-27, 4 g, 22 ms half sine, 3 times in each of 6 axes
Vibration					IEC68-2-6, 10-500 Hz, 2 g 10 mins/sweep. 60 mins for each of 3 axes

### EMC: Emissions

Phenomenon	Standard	Test Level	Criteria	Notes & Conditions
Conducted	EN55022	Class B		
Radiated	EN55022	Class B		
Harmonic Current	EN61000-3-2	Class A		
Voltage Fluctuations	EN61000-3-3			

### EMC: Immunity

Phenomenon	Standard	Test Level	Criteria	Notes & Conditions
ESD Immunity	EN61000-4-2	6 kV	A	Contact
		8 kV		Air Discharge
Radiated Immunity	EN61000-4-3	10 V/m	A	
EFT/Burst	EN61000-4-4	3	A	
Surges	EN61000-4-5	Installation class 3	A	
Conducted	EN61000-4-6	10 V	A	
Magnetic Fields	EN61000-4-8	4	A	
Dips and Interruptions	EN55024	Dip: 30%, 10 ms	A	
		Dip: 60%, 100 ms	A/B	High Line/Low Line
		Dip: 100%, 5000 ms	B	

### Safety Approvals

Safety Agency	Safety Standard	Notes & Conditions
UL	UL508	Industrial Control Equipment
TUV	EN60950-1 A12:2011	Information Technology
CB	IEC60950-1 +A1:2009	Information Technology

### Mechanical Details

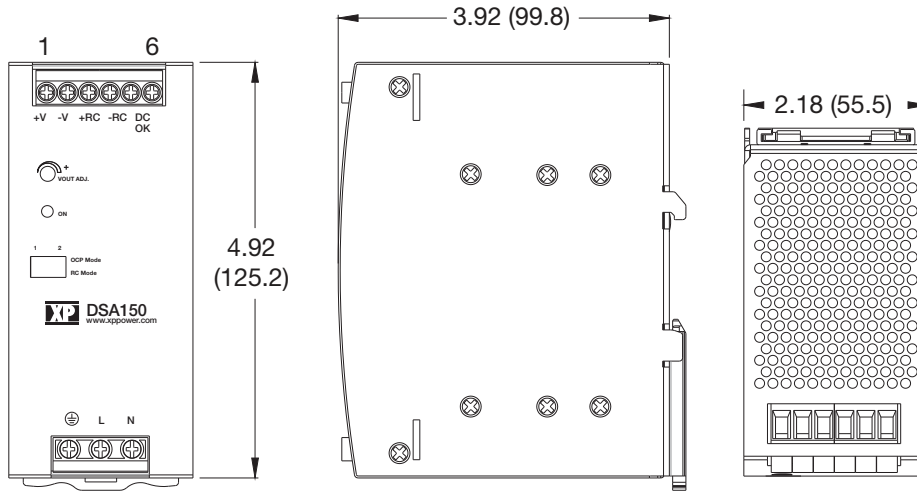

Pin Connector		
Conn	Pin	Designation
AC I/P	1	Ground
	2	L
	3	N
DC O/P	1	+Vout
	2	-Vout
	3	+RC
	4	-RC
	5	DC OK
	6	DC OK

### Notes

- All dimensions in inches (mm)
- Weight: 1.916 lbs (860g)
- Tolerance:  $\pm 0.02$  in ( $\pm 0.5$  mm)
- Screw terminal: 10-24 AWG cables size.
- Connection screw maximum torque: Input: 4.4lbs-in (0.5 Nm), Output: 7.0 lbs-in (0.79 Nm).

### Application Notes

#### Derating Curves

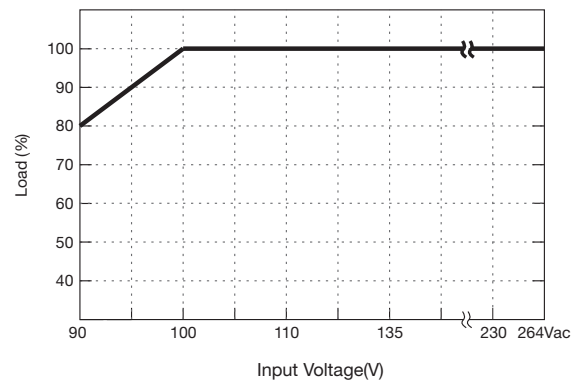
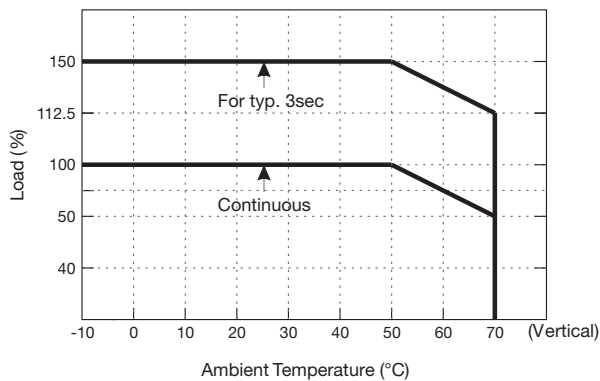

### DC OK

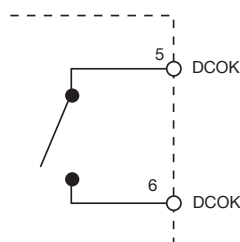

Open = Output fail, if voltage drops below 45% of nominal  
 Closed = Output good

Contact Rating: 0.3 A at 60 VDC, 1.0 A at 30 VDC, 0.5 A at 30 VAC.  
 500 VDC isolation to output.

### Application Notes

#### Peak Loading

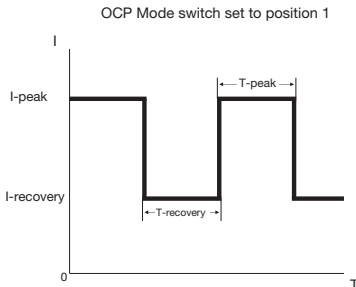

The peak loading and overload characteristics can be programmed into one of two modes by appropriate selection of the OCP mode switch on the front panel.

A peak load of up-to 150% can be taken for a given duration. This duration depends on the percentage of peak load taken and can be determined by graph A below.

If the load is reduced to less than 100% of nominal either before or at the end of the duration, then there is a period of recovery needed to allow the power supply to cool down before the peak load can be re-applied. The time required for recovery depends on the amount of reduction of load and can be determined by graph B below.

However, if the peak load period exceeds the duration indicated by graph A the output will go into constant current mode for protection. The constant current value will be 105% of the nominal rating.

During constant current operation, if the output voltage should fall below 40% of the rated voltage then the output will turn off and try to restart for five times before turning off permanently. Once this has happened, the output will need to be reset by turning the AC mains off and on again.

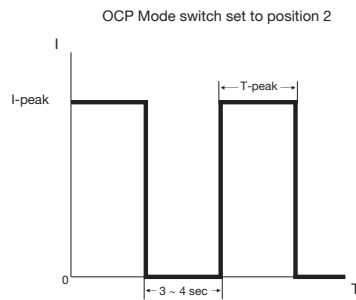

A peak load of up-to 150% can be taken for a given duration. This duration depends on the percentage of peak load taken as described by graph A.

Once the peak load duration is exceeded, the output will turn off for 3-4 seconds before automatically restarting.

GRAPH A

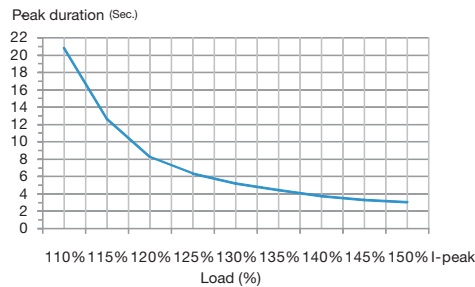

GRAPH B

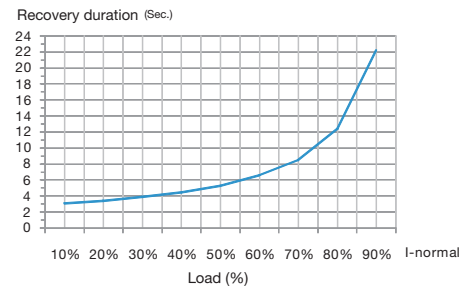

#### Remote Control

The output can be controlled by applying a voltage between pin 3 of the DC output with respect to pin 4. The effect of the control is dependant upon the RC switch setting on the front panel.

If the switch is set to position 1 then the output can be disabled by applying a suitable voltage.

If the switch is set to position 2 then the output can be enabled by applying a voltage. In the range of 2.5V to 9.0V limited to 20 mA.

Switch Position	Pin 3 Voltage with respect to Pin 4	Output
1	<0.8 V or Open Circuit	ON
1	>2.5 V, <9.0 V	OFF
2	<0.8 V or Open Circuit	OFF
2	>2.5 V, <9.0 V	ON